

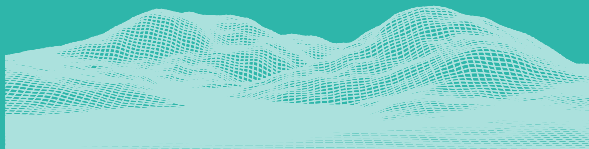

SONIC
LS+





Dear User,

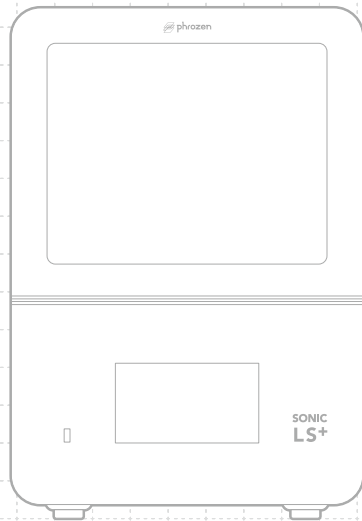

Thank you for joining us. Please read the Sonic LS+ manual thoroughly and follow the instructions step by step to get the best printing experience.





01 Safety and Compliance



Safety Messages

Symbol	Name	Description
	"ON" (power)	Indicates connection to the mains supply.
○	"OFF" (power)	Indicates disconnection from the mains supply.
	General warning sign	Signifies a general warning.
	Caution: hot surface	Indicates that the marked item can be hot and should not be touched when it is still hot.
	Warning: dangerous voltage	Indicates hazards arising from dangerous voltages.

Symbol	Name	Description
	Warning: hand crush hazard	Indicates a risk of hand or finger injury due to moving mechanical parts or pinch points.
	Warning: ultraviolet radiation	Exposure to UV light can be harmful to skin and eyes, using UV cover on the unit or protective equipment to avoid direct eye or skin exposure to UV light.
	Earth/Ground	Used to identify an earth (ground) terminal.

Certifications and Compliance

Symbol	Name	Description
	Manufacturer	Indicates the medical device manufacturer.
	Authorized representative in the European Community	Indicates the Authorized representative in the European Community.
	Authorized representative in the United Kingdom.	Indicates the Authorized Representative in the United Kingdom.

Symbol	Name	Description
	WEEE symbol	Indicates that waste electrical and electronic equipment must not be disposed of as unsorted municipal waste and must be collected separately. Please contact an authorized representative of the manufacturer for information concerning the decommissioning of your equipment.
	Serial number	Indicates the manufacturer's serial number.
	Consult instructions for use	Indicates that the user should consult the instructions for use before operating the device.



Hazards

Electrical Safety

DANGER

- Operate the device only under the conditions specified in this manual. Failure to do so may result in equipment damage, inaccurate printing results, or personal injury.
- Do not remove the device cover or expose internal components, as this may lead to electric shock.

DANGER

- To prevent personal injury, place the device on a stable, level surface that can support its weight and ensure that it is securely positioned to prevent accidental movement.
- Do not place your hands or head inside the device while it is operating. Doing so may cause personal injury.

Power Supply Requirements

WARNING

- Use only the power cord provided by the manufacturer. It is designed specifically for this device and should not be used with other equipment.
- The power outlet must be a standard three-prong socket, and the ground terminal must be connected to the protective grounding of the power system (as required or permitted by local regulations).

- Ensure that the grounding cable is connected according to applicable standard or with guidance from an experienced electrician.
- Make sure the power switch is in the off position before connecting to the power supply.
- Before disconnecting from the power source, ensure the printing task is complete, the control software is closed, and all access doors or covers are shut. Failure to do so may damage the device.

Daily Maintenance

WARNING

Maintaining the power supply

- If the device will not be used for seven days or longer, turn it off and unplug the power cord.
- Before each use, check that the power cord and cables are securely connected and undamaged, or contact the technical support if a replacement is required.

Regulatory Information

1 FCC Information for USA

- This device complies with part 15 of the FCC Rules. Operation is subject to the following two conditions:
 - This device may not cause harmful interference, and
 - this device must accept any interference received, including interference that may cause undesired operation.
- This device has been tested and found to comply with the limits for a Class B digital device, pursuant to Part 15 of the FCC Rules. These limits are designed to provide reasonable protection against harmful interference in a residential installation. This device generates, uses, and can radiate radio frequency energy and, if not installed and used in accordance with the instructions, may cause harmful interference to radio communications. However, there is no guarantee that interference will not occur in a particular installation. If this device does cause harmful interference to radio or television reception, which can be determined by turning the device off and on, the user is encouraged to try to correct the interference by one of the following measures:
 - Reorient or relocate the receiving antenna.
 - Increase the separation between the device and receiver.
 - Connect the device into an outlet on a circuit different from that to which the receiver is connected.
 - Consult the dealer or an experienced radio/TV technician for help.
- Changes or modifications not expressly approved by the party responsible for compliance could void the user's authority to operate the device.
- The device has been evaluated to meet general RF exposure requirement.

- This device complies with FCC radiation exposure limits set forth for an uncontrolled environment.
- To comply with FCC RF exposure requirements, the device must be installed and operated 20 cm (8 inches) or more between the product and all person's body.
- This device complies with FCC radiation exposure limits set forth for an uncontrolled environment.

2 ISED Information for Canada

• ISED Canada RSS-Gen Notice:

(EN)

This device contains licence-exempt transmitter(s)/receiver(s) that comply with Innovation, Science and Economic Development Canada's licence-exempt RSS(s). Operation is subject to the following two conditions:

- This device may not cause interference.
- This device must accept any interference, including interference that may cause undesired operation of the device.

(FR)

L'émetteur/récepteur exempt de licence contenu dans le présent appareil est conforme aux CNR d'Innovation, Sciences et Développement économique Canada applicables aux appareils radio exempts de licence. L'exploitation est autorisée aux deux conditions suivantes :

- L'appareil ne doit pas produire de brouillage;
- L'appareil doit accepter tout brouillage radioélectrique subi, même si le brouillage est susceptible d'en compromettre le fonctionnement.

- CAN ICES-003(B) / NMB-003(B)

- **RF Exposure Guidance Statement**

(EN)

- This device should be installed and operated with a minimum distance 20 cm between the radiator & your body.
- Please note that the 5150–5250 MHz band is restricted to indoor use only.

(FR)

- Lors de l'installation et du fonctionnement de cet équipement, la distance minimale entre le radiateur et le corps doit être de 20 cm
- Remarque : la bande de fréquences 5150–5250 MHz est réservée à une utilisation à l'intérieur uniquement.

- **Detachable antennas (If use)**

(EN)

For licence-exempt device with detachable antennas

This radio transmitter has been approved by Innovation, Science and Economic Development Canada to operate with the antenna types listed below, with the maximum permissible gain indicated. Antenna types not included in this list that have a gain greater than the maximum gain indicated for any type listed are strictly prohibited for use with this device.

Antenna Type: External rubber stick antenna
WIFI 2.4GHz Peak ∙ Gain: 4.47dBi
WIFI 5GHz Peak ∙ Gain: B1: 4.71dBi; B4: 3.86dBi

(FR)

L'antenne Type: External rubber stick antenna
WIFI 2.4GHz Peak ∙ Gain: 4.47dBi
WIFI 5GHz Peak ∙ Gain: B1: 4.71dBi; B4: 3.86dBi

3 NCC Warning:

- The product has obtained certification for low-frequency radiation materials that comply with the core standards. Users are advised that the product should not interfere with self-adjusting frequency, and it enhances power conversion efficiency and functionality.
- Low-frequency radiation materials must be used without interfering with flight safety and communications. In case of interference, the product should be immediately powered off, and improvements must be made to prevent abnormal usage. Communication with authorities should be made before using the product to ensure compliance with telecommunications regulations.
- Low-frequency radiation materials must comply with laws governing telecommunications, industry standards, and medical equipment related to electromagnetic radiation.
- The product should avoid interference with nearby communication systems.
- The system should be adjusted through a fixed-point user application method to ensure it aligns with established standards.

02 Key Notes

Operating Environment

- Store your the product in a dry and well-ventilated environment. Place it on a flat surface and avoid direct sunlight exposure.
- For indoor use only.
- Keep the product and its accessories away from children.



20 ~ 30 °C
68 ~ 86 °F | 40 ~ 60% RH

For use below 2000 m altitude.



Key Notes Before Getting Started

When removing the protective film, only remove the protective film with a tab. Do not remove any film without a tab.



When installing the resin vat, please align the bottom of the resin vat with the platform grooves to avoid damage caused by the resin vat scratching the LCD.

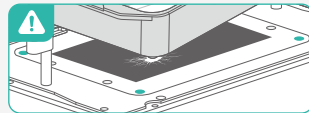

Key Notes During Operation

⚠ Please do not touch the heater while it is still hot to avoid burns.

Do not allow any liquid to contact the connector to prevent short circuits.

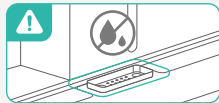
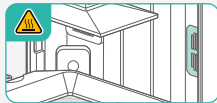

Protection measures

When handling resins or prints, please wear personal protective equipment such as gloves, masks, protective goggles, and long-sleeved clothes.



Maintenance

When cleaning the printer, use 95% alcohol and Lint Free Wipes to carefully clean the printer, resin vat, and the build plate.



03 Introduction

Product Description

Intended Use

For printing dental applications.

Working Principle

Utilizes LCD-based masked stereolithography (MSLA) to cure resin layer-by-layer with UV light.

Structural Composition

Includes an LCD, UV LED light source, resin vat, build plate, Z-axis motion system, and touch panel.

Printer Parts

PART.1

Interior Light

* The interior light is programmed to turn off after 10 minutes of operation. Prolonged lighting can partially cure the resin, potentially impacting printing quality.

PART.2

Air Filtration System

PART.3

Camera

PART.4

Large Heating Resin Vat Standard Heating Resin Vat

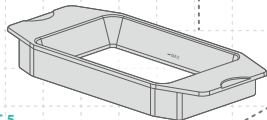

PART.5

LCD

PART.6

USB Port

PART.7

Touch Panel

PART.8

Lift-Up Lid

PART.9

Large Build Plate Standard Build Plate

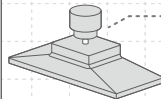

PART.10

Heater

PART.11

Z-Axis

PART.12

Wi-Fi Antenna

PART.13

Power Switch & Socket

PART.14

Ethernet Port

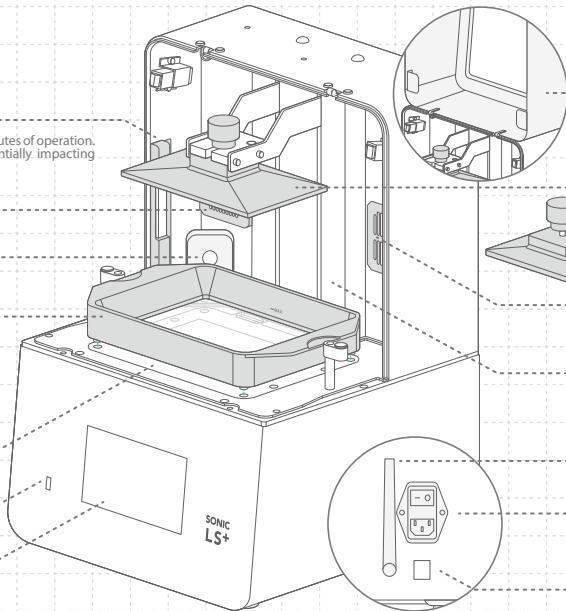

Specifications

Model	Phrozen Sonic LS+ 3D Printer
Input	100-240V~ : 50/60 Hz
Power	600W

Operation

System	Phrozen OS
Tough Panel	7-inch
Slicer	Phrozen Dental Synergy Slicer
Connectivity	USB Ethernet Wi-Fi
Built-in Memory	8.0 GB ²

Printing Specifications

Technology	Resin 3D Printer - LCD Type
Light Source	385 nm UV LED
XY Resolution	34 μm
Layer Thickness	30 / 50 / 100 μm
Compatible File Format	.prz / .ctb

Hardware Specifications

Product Dimensions (W x D x H)	38 x 36 x 55 cm
Maximum Product Height ³	93.2 cm
Build Volume ⁴ (W x D x H)	Large Build Plate - 19.8 x 12.5 x 17.5 cm
	Standard Build Plate - 16.8 x 7.4 x 17.5 cm
Weight	23 kg
Radio Frequency and corresponding Maximum Conducted Output Power	2400MHz - 2483.5MHz 18dBm
	5150MHz - 5250MHz 10dBm
	5725MHz - 5850MHz 11dBm

¹ All specifications were tested in a laboratory and are subject to change without prior notice. For the latest update, please refer to Phrozen's official website.

² Actual usable capacity may be less due to system files and system maintenance.

³ "Maximum Product Height" refers to the product's maximum height with the lift-up lid open. Please allow sufficient operating clearance.

⁴ The final print dimensions may deviate from those displayed in the slicing software due to hardware tolerances, slicing settings, or post-processing. Please refer to the actual dimensions of the printed object.

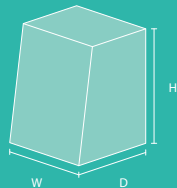

Toolbox



Warranty Card



Gloves



Power Cord 1.5 m



Plastic Funnel



Metal Scraper



Plastic Scraper



T-Hex Wrench x2



USB



DS Slicer



Wi-Fi Antenna



Magnetic Fan Dust Filter



Sandpaper



Resin Filter Paper x3
(100 Mesh)

04 Get Started

When using the printer for the first time, we recommend following the step-by-step instructions to complete your first test print.

- 1 Select interface language.
- 2 Name your Sonic LS+.
- 3 Connect to the internet.
- 4 Enter the Initial Setup.
- 5 Here are 3 modes in LCD test:
Light up, LCD Grid, and Blackout, please select each mode and check the LCD is showing the correct pattern.
- 6 Following the instruction to complete Smart Leveling.
- 7 Once you finish the setup of the printer, you can start the first test print.

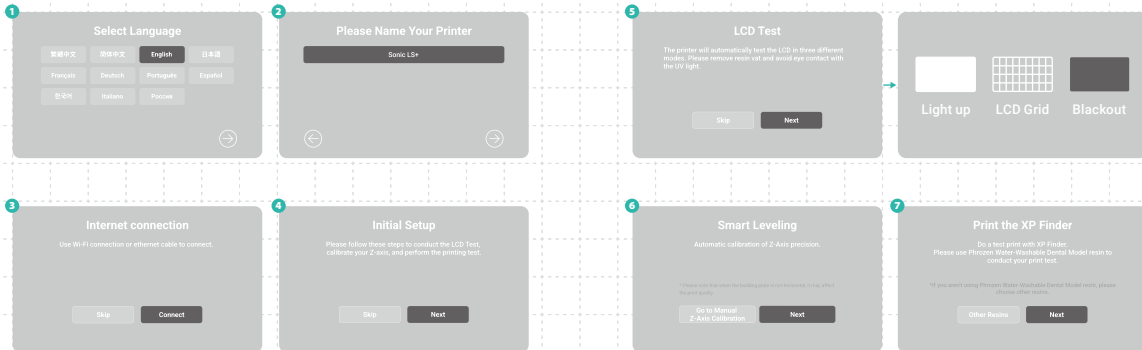

05 Function

Smart Leveling

Click "Tools"  > "Z-Axis Control"  > "Smart Leveling"  . Follow the instruction for Smart Leveling:

- 1 Remove the resin vat, install the build plate and tighten the hand screws, then place a piece of A4 paper on top of the LCD.
- 2 Wait for the build plate to rise to the top and then descend to the bottom to trigger the actuators.
- 3 Pull the paper and determine if the friction at all corners of the paper is equal.
If paper in all corners is too tight or too loose, you can adjust it using Z-Offset.
- 4 Click  , Smart Leveling is completed after the resin vat returns to its original position.

* If you replaced or adjusted the build plate, Z-axis, LCD, or LCD protector, please do the "Manual Z-Axis Calibration".

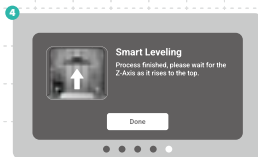
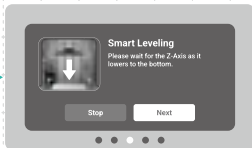

Manual Z-Axis Calibration

Click "Tools"  > "Z-Axis Control"  > "Smart Leveling"  > Click  . Follow the on-screen prompts for manual Z-Axis calibration:

- 1 Remove the resin vat, and place an A4 paper on top of the LCD.
- 2 Wait for the build plate to rise to the top.
- 3 Install the build plate and lock the knob screws, then loosen four screws on both sides.
- 4 Once the build plate has been lowered to the bottom, gently press the build plate and tighten the four screws on both sides of the

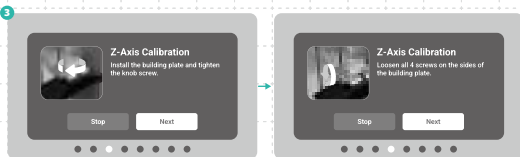
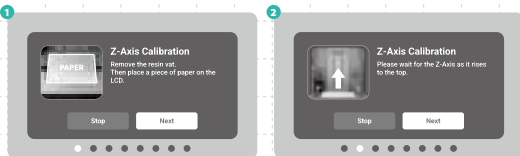

- 5 build plate diagonally.
- 6 Pull the paper and determine if the friction at all corners of the paper is equal. If paper in all corners is too tight or too loose, you can adjust it using Z-Offset.
- 6 Click "Done"  and wait for the build plate to return to top to complete the manual Z-Axis calibration.

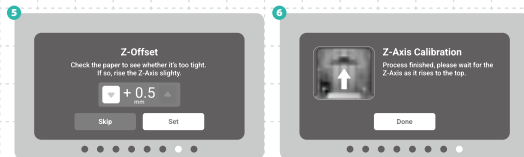
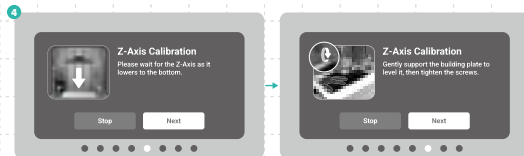

Z-Axis Control

You can click "Move to Z-Axis Top"  to enable this function.



Install the Resin Vat

- 1 Put the connector at the back side and align the screws at the bottom of the resin vat with the platform grooves to place the resin vat.
- 2 Gently press both sides of the resin vat and rotate both toggles inward to fix the resin vat in place.

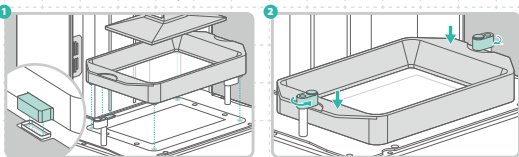

Remove the Resin Vat

Gently press the resin vat and rotate both toggles outward to remove the resin vat.

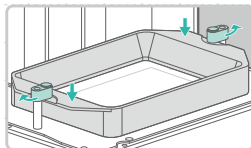

Preheat

When "Preheat" is enabled, the heating resin vat and heater will warm up for a specified amount of time duration before printing.

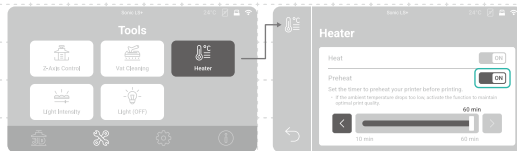

* Printing will start after the preset heating time.

Residue Detection

This feature can be found by select "Settings"  > "System" .



If enabled, the printer will check for any solid residue between the resin vat and the building plate in its initial descent. Printing will be paused and a warning message will appear on the screen if such residue is detected.

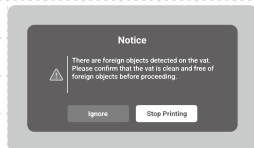

Print Risk Warning



This feature can be found by select "Settings"  > "System" .



If enabled, the printer will monitor the release condition during printing. A warning message will appear on the screen if unusual release forces are detected.



Start Printing

- 1 Plug the USB, USB icon  will appear in the upper right corner of the screen.
- 2 View USB files.
- 3 Select the file and click .
- 4 When you start printing, the printer interface displays the current printing status.

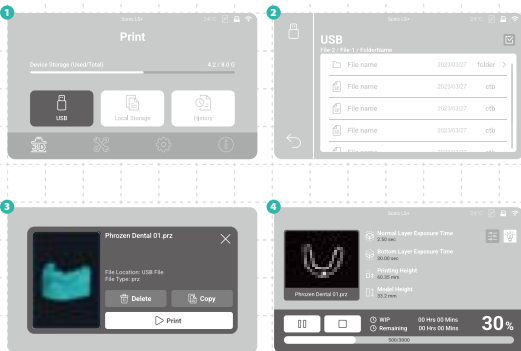

06 Firmware Update

Update through OTA

If a new firmware version is available, the notification dot will appear on "System Update" , you can click and update.

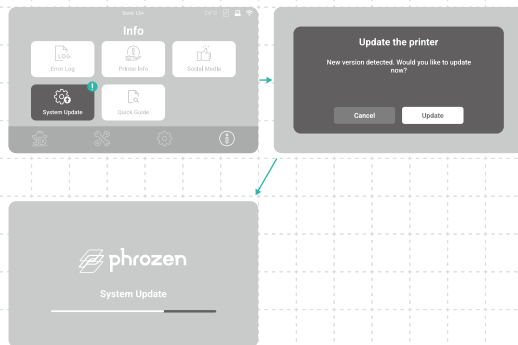

Update through USB

To perform Firmware Update through USB, please visit [Firmware Download Page](#) to view full instructions for Firmware Update.

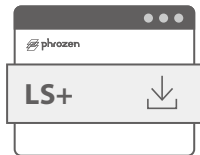

After-Sales Service & Warranty

- Phrozen offers a one-year warranty for all parts and LCD, excluding other consumable components and PFA (nFEP) film.
- If you have any questions while using Sonic LS+, please scan the QR Code to visit the Phrozen Help Center, where you can find helpful product guides or get in touch with our support team.



Phrozen Dental
Help Center

Congratulations!

You have just completed your first run.
We hope you've had a great experience!

Please follow Phrozen's social media accounts
to learn more about printing tips and share your
printing experience with the community.



Facebook



Facebook Group



Instagram



Phrozen Dental
Official Website



YouTube